

# Wind Turbine Model

## Background

Wind power generators or wind turbines have come a long way from the ancient windmills that were used for pumping water or grinding grain. The modern wind turbine resembles an airplane in its sophistication, engineering and scale. This turbine is modeled after the Vestas 600 which are widely installed in wind farms across the US and Europe. The blades are 44 meters in diameter and sweep and area of 1521 m<sup>2</sup>. The generator and hub sit 35m above the ground. The blades move comparatively slowly but capture a good percentage of the energy in the wind. It generates 600 kW at 28 rpm.

Three airfoil shaped blades are mounted to a hub in a rotating ring so the pitch can be changed to adjust to the wind speed. The hub is connected to a main gear that drives smaller step up gears which are in run the electrical generator. The blades generate high torque. The gear box is large enough for several workmen to service the generator. They access the space up a ladder inside the hollow tower. The blade pitch the direction of the machine are computer controlled from a central control center that watches over 50-100 wind turbines.

## Construction

- 1) Print out all the parts on card stock. Cut out the solid outlines and fold the dotted lines. Refer to the exploded diagram on the next page.
- 2) Fold the blades with a gentle bend at the leading edge, do not press the fold flat, this helps keep the airfoil shape. Glue the airfoil shape patterns A and B inside the blade at the locations indicated. Glue the trailing edge. Use paper clips to hold the edge down because it will want to spring back.
- 3) Fold, roll, and assemble the blade mount tubes. Use a pen or dowel to help roll these and to keep the diameter the same for all three. Attach these to blades so that the curved leading edge of the blade round shape of the tube, glue in place. The flat trailing edge extends beyond the mount.
- 4) Construct the hub. Roll the hub blade mount tubes to fit snugly around the outside of the blade mounts on the blades. Press a bamboo skewer or 1/8" wooden dowel into the hub at the center. Slide the blades into the hub and adjust the angle. They should be stiff to turn but adjustable. Add the conical hub nose.
- 5) Fold and assemble the main housing. Add the three vertical end supports.
- 6) Build the gears and press a dowel into these.
- 7) Insert the gears into dowels and into the appropriate holes on the vertical supports
- 8) Cut and fold the cowling
- 9) Cut and roll the two pieces of the tower, glue these one on top of the other. Slide the tower support collar over the narrow end of the tower, 1cm from the top.
- 10) Place the housing on top of the tower by inserting the tower top into the hole on the bottom of the housing. Anchor the tower bottom to a piece of cardboard.

## Try it out

- 1) Place the turbine in the wind and adjust the parts until it move freely.
- 2) Try different blade pitches (angle of attack) to see what works best.
- 3) Try the turbine in a strong wind or in front of a strong fan. Try feathering the blades.

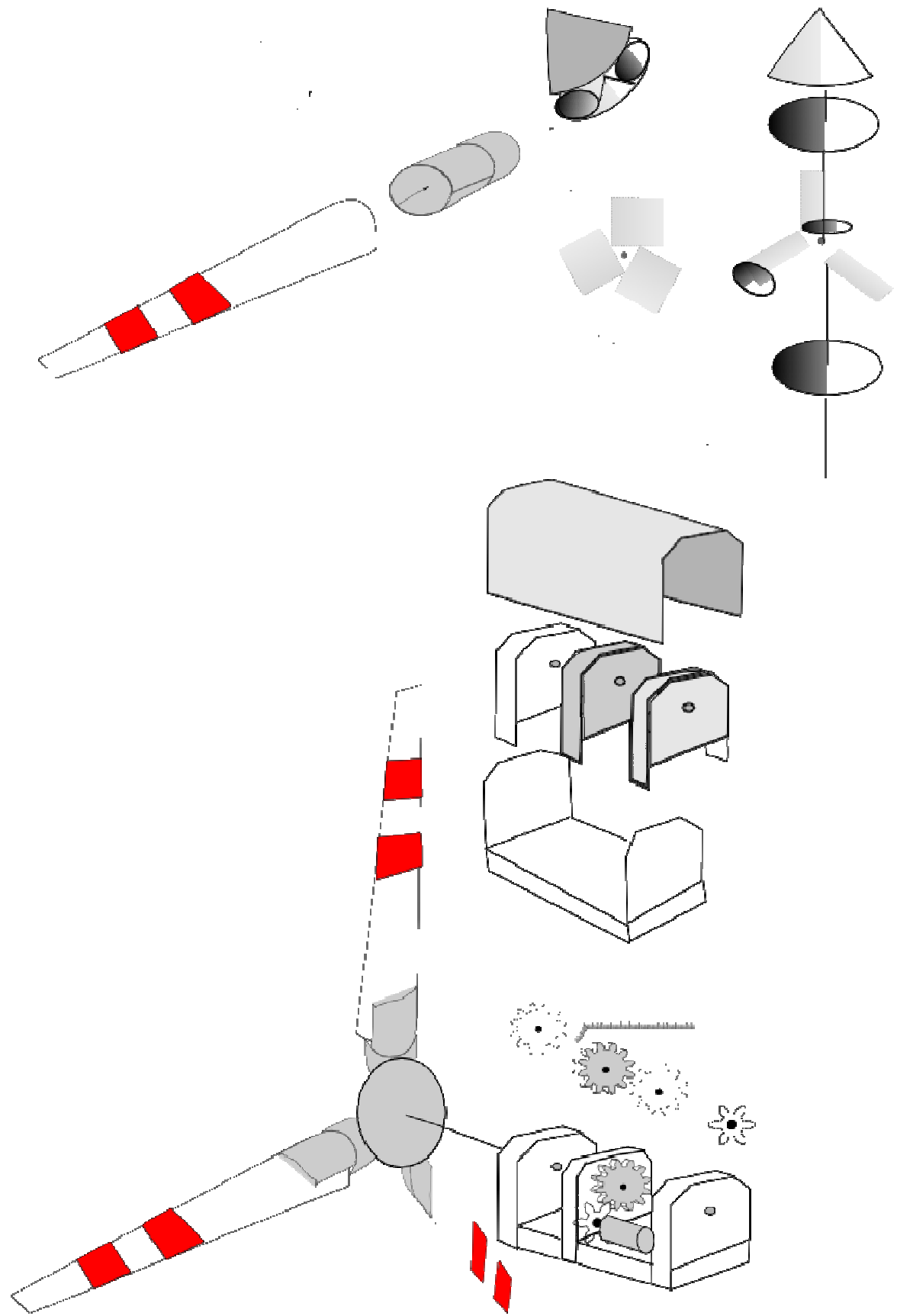



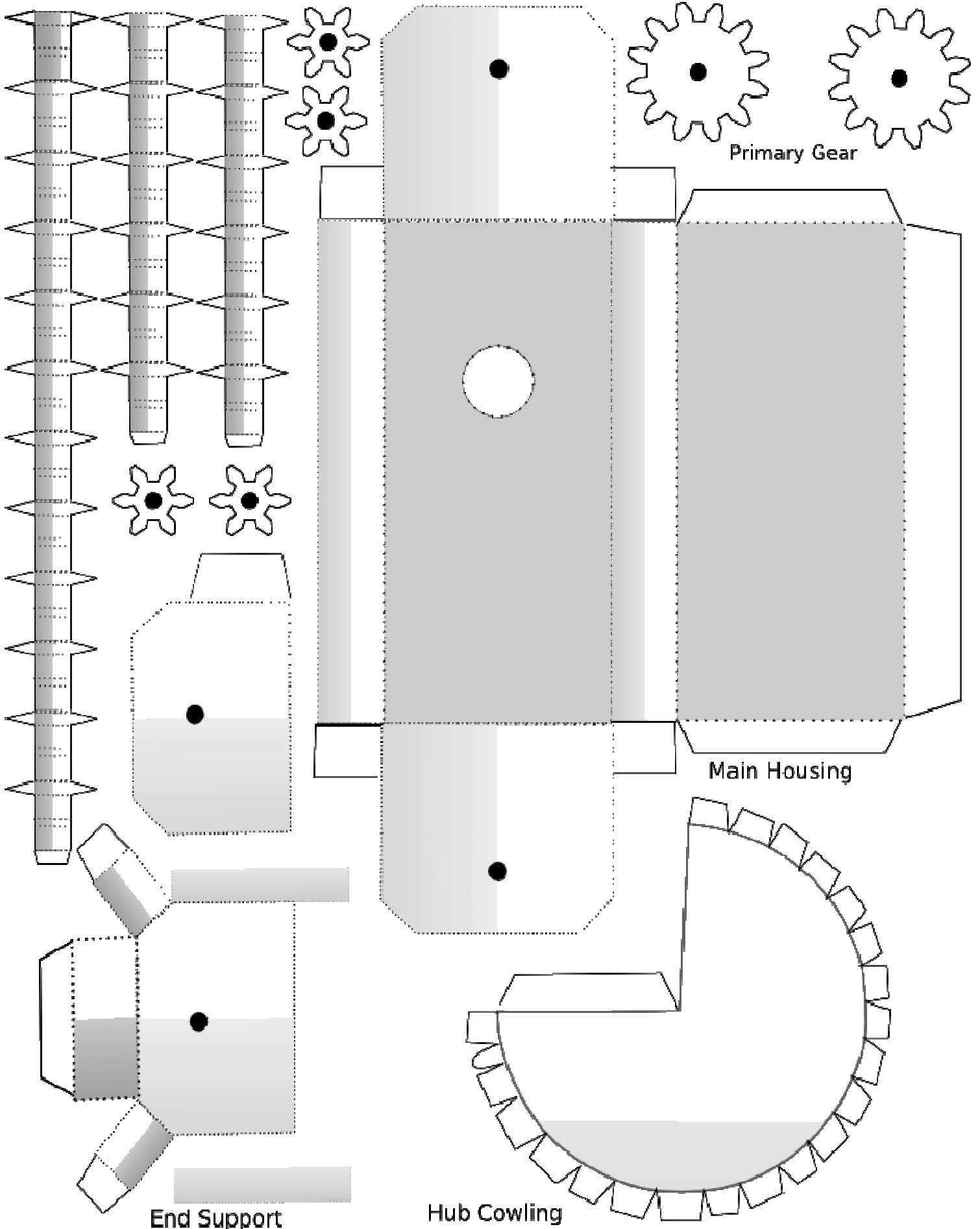

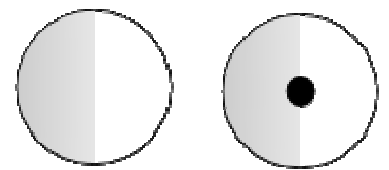
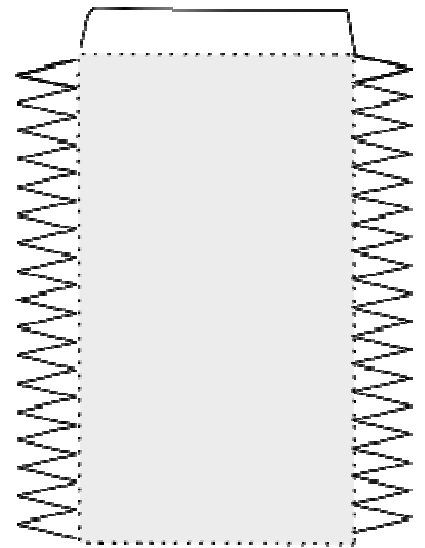
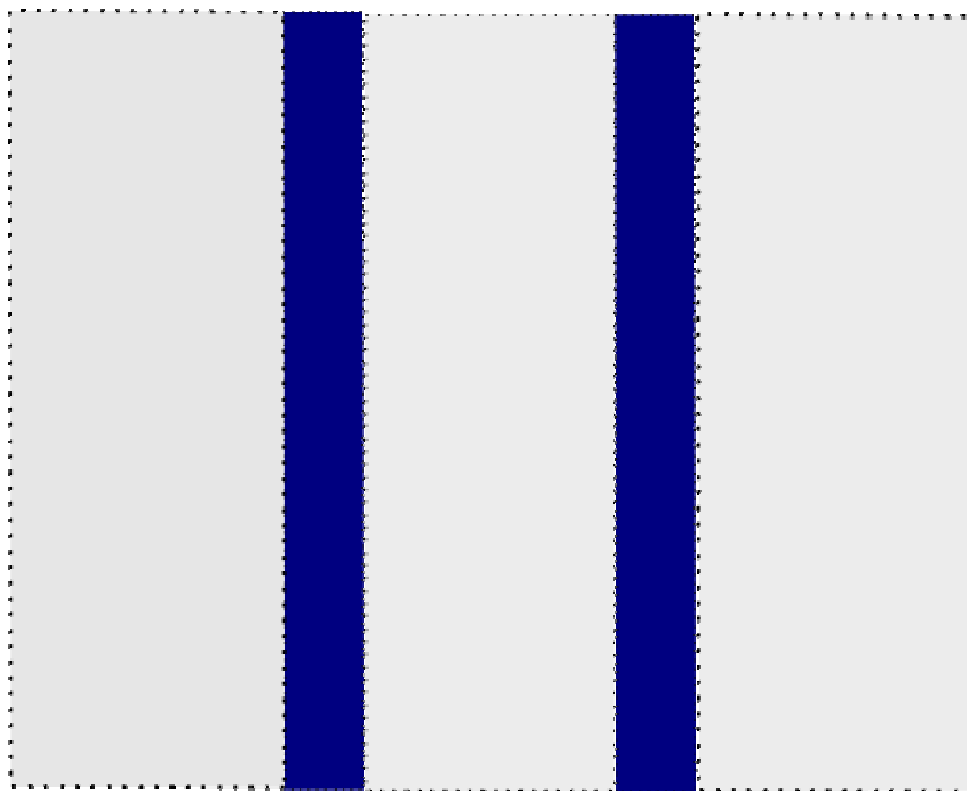
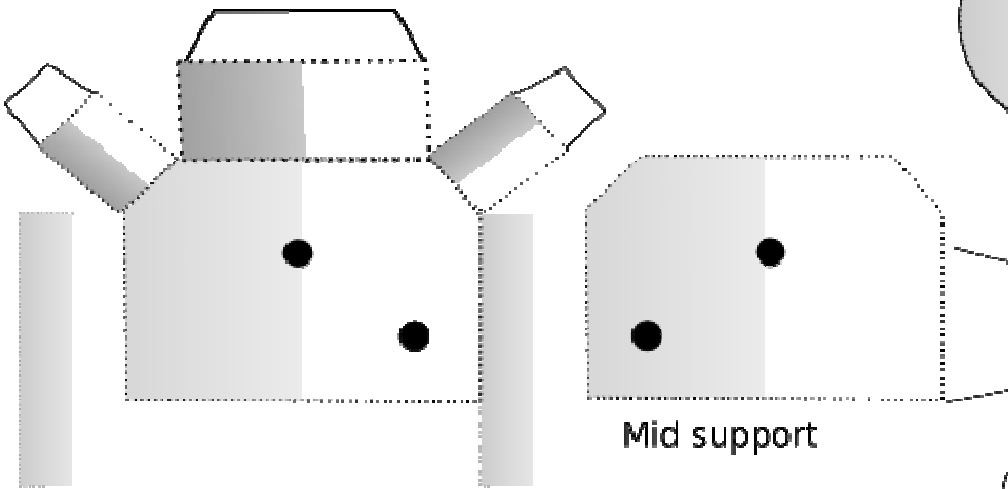
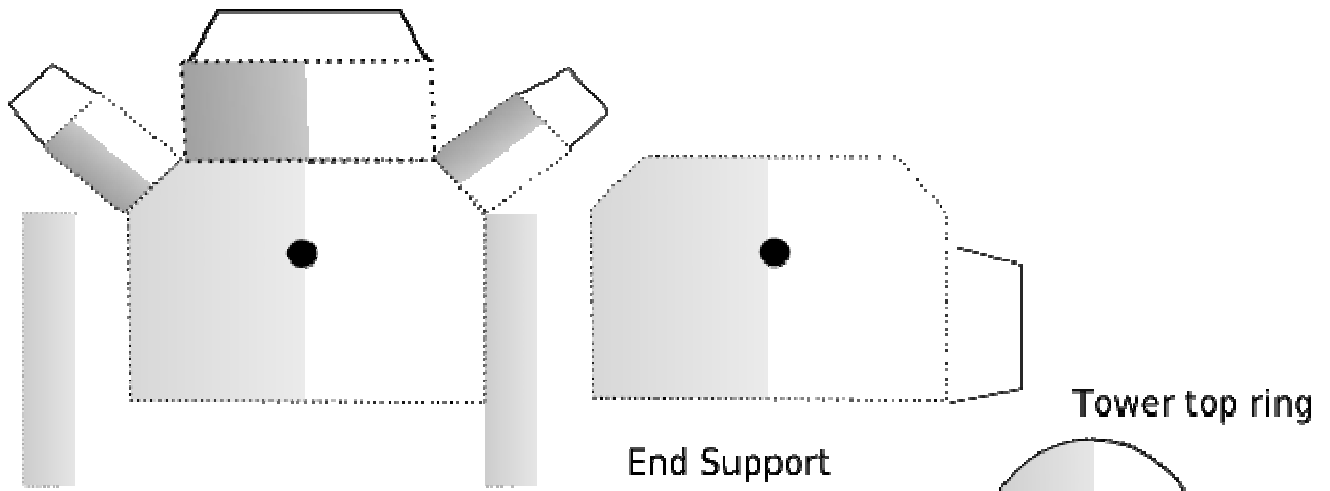

**Hub Blade mounts**

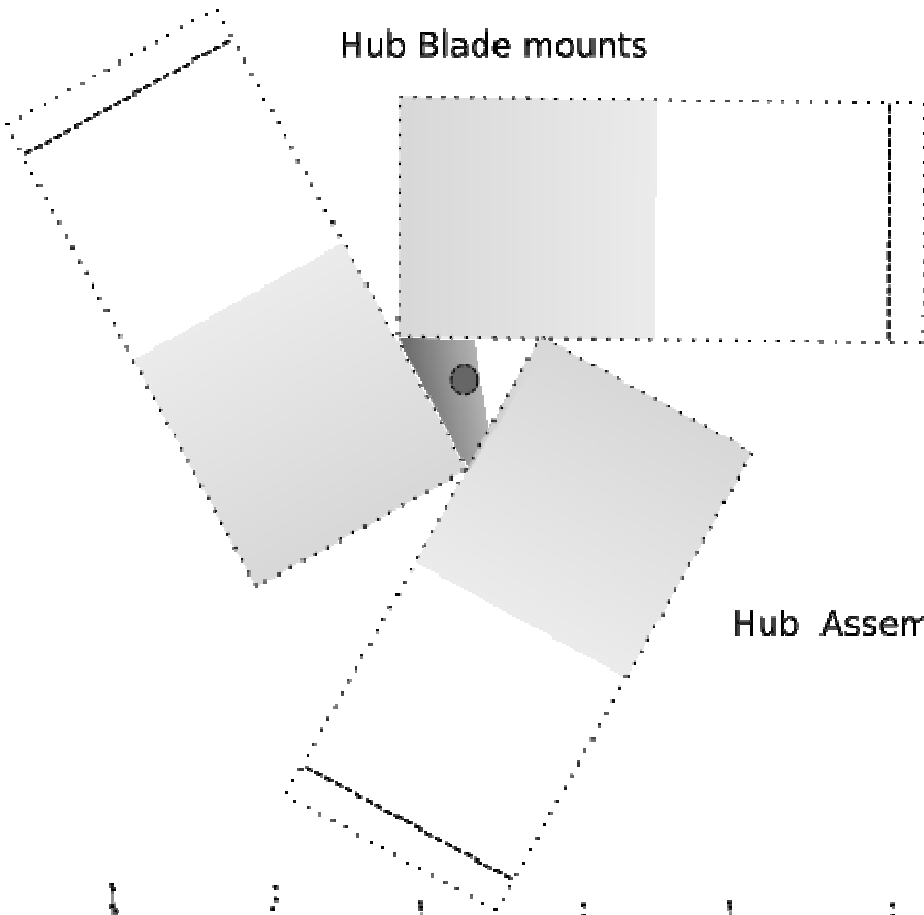

**Hub Assembly**

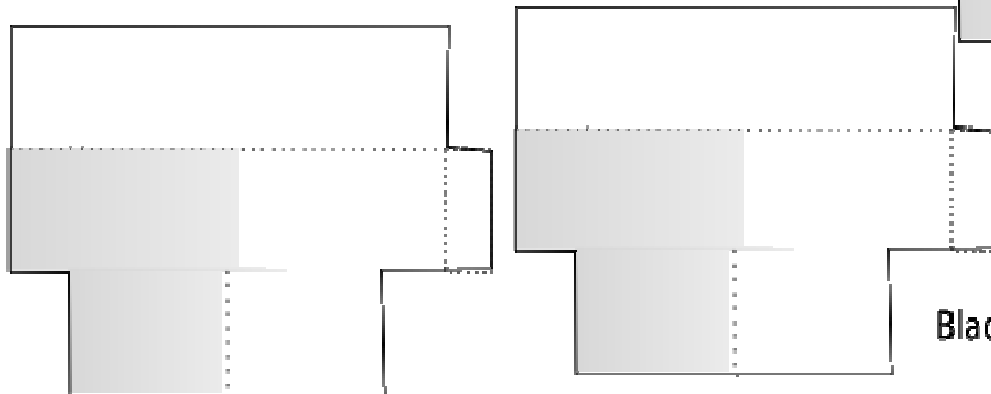
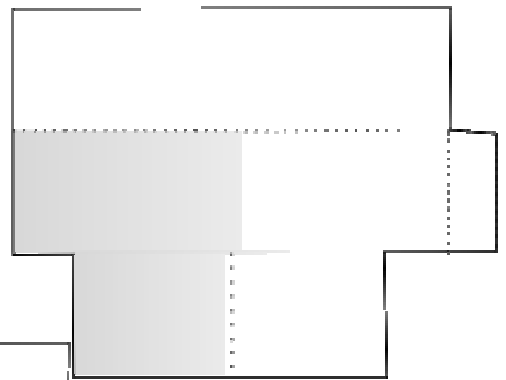
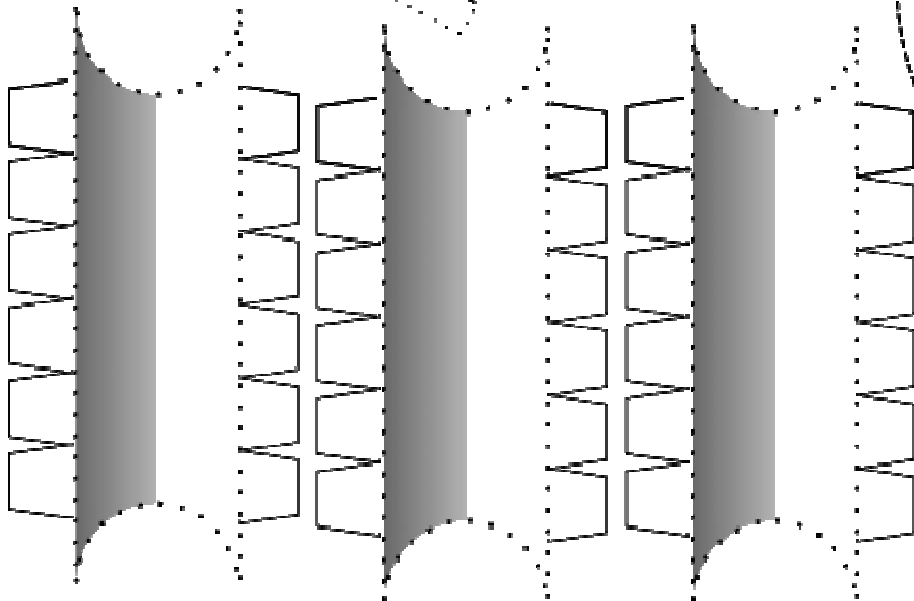

**Blade Mount Tubes**

